

OVEN INSTALLATION AND USER MANUAL

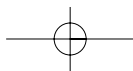

FAGOR 

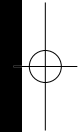
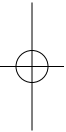
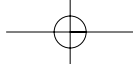

OVENS

▶ CONTENTS

GREETING

1. SAFETY NOTICES	6
1.1. Installation and assembly.....	6
1.2. Use and operation.....	7
1.3. Safety for children.....	8
1.4. Care and cleaning.....	8
2. INSTALLATION AND ASSEMBLY	9
2.1. Unpacking.....	9
2.2. Connection to the mains electricity.....	9
3. USE OF THE OVEN AND PRACTICAL TIPS	14
3.1. Before using the oven for the first time.....	14
3.2. General description.....	15
3.3. Operation of the oven.....	17
3.4. Accessories.....	18
3.5. Rotating spit.....	22
3.6. Practical tips and cooking table.....	23
4. CLEANING AND MAINTENANCE	28
4.1. How to clean.....	28
4.1.1. The outside of the oven.....	28
4.1.2. The inside of the oven.....	29
4.1.3. Accessories.....	32
4.1.4. Side grilles.....	32
4.2. How to replace the bulb in the interior light.....	33
5. TROUBLESHOOTING	34
6. ENVIRONMENTAL NOTE	36
6.1. Protecting the environmen.....	36
6.2. Energy-saving tips.....	37

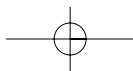
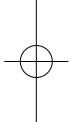
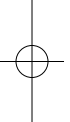
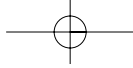



GREETING

Dear client,

You are now the proud owner of a **FAGOR** oven and we would like to thank you for the confidence you have shown in us.

FAGOR provides you with a new generation of domestic appliances that contribute to an improvement in your quality of life thanks to our range of innovative, easy to use and environmentally-friendly products.

The range of **FAGOR** products offers you a wide selection of cooking hobs, extractor fans, microwave ovens, dishwashers, washing machines, and refrigerators that you can combine with your new oven.

When it comes to our products, it is our wish to respond to your demands as best we can round the clock, for this reason we will be at your full disposal through our Customer Service. In addition, you will be able to contact us via the Internet on our web page, **www.fagor.com**, where you will also be able to find updated information about the latest innovations from the **FAGOR** brand. Don't hesitate to ask us.

Before using your oven for the first time, we recommend you read the user manuals carefully. You will find there the information you will need to make the most of your new **FAGOR** oven. Please pay special attention to all the safety advice and to the comments on how to use and care for your oven correctly.

At the same time, we recommend you keep these manuals in a safe place as you may find them useful in the future if you need to consult any doubt that might arise. If you pass the appliance on to another person, please be sure to enclose the manuals.

Warm greetings and welcome to the family of **FAGOR** clients.

The **FAGOR** brand.

▶ 1. SAFETY NOTICES

1.1. INSTALLATION AND ASSEMBLY

- Once all the packaging materials have been removed, check that the oven is not damaged and that the power cable is in perfect condition. If you detect any damage or minor problems due to the transportation of the oven, do not use it and call the Customer Service Centre.
- Any work required for installing and repairing this oven must be done solely and exclusively by an authorised fitter and following the manufacturer's instructions. The manufacturer declines any and all liability if the current standards are not complied with.
- The identification plate on the lower front part of the oven provides the technical details and identification number of the apparatus. This must be consulted before proceeding with any electrical connections.
- It is dangerous to alter the characteristics or modify the product in any way.
- For reasons of electrical safety, installable ovens must be fitted into appropriate units and these must comply with the standards currently in force for this purpose.

IMPORTANT

Any manipulation of the oven or cooking hob for the purposes of installation, maintenance, etc. must be carried out with the oven disconnected from the mains electricity.

1.2. USE AND OPERATION

- This oven has been designed solely for domestic use. Use it solely and exclusively for cooking food, never for any other purpose.
- The oven must always be operated with the door closed, no matter which programme you choose, including the grill.
- Open the oven door carefully, hot steam may come out.
- Never pour water directly onto the inside of a hot oven, the enamel might be damaged.
- After cooking, never pick up the bowls or pans used with your bare hands; always use an insulating cloth or oven glove.
- Do not leave the oven to cool down with the door open. Even if the oven door is only left a little ajar, the front panels of the adjacent units may be damaged over time.
- Never store inflammable objects inside the oven.
- Never place food or dishes directly onto the base of the oven. Always use a tray or rack.
- Do not sit or lean on the oven door, it might lead to problems with the door closure adjustment.
- After using the oven, all the controls must be turned back to the "0" position.
- If the oven stops working for any reason, disconnect it and call the Technical Service.
- (Depending on the model)
The oven is equipped with a fan which helps to expel steam and ensures that the furniture remains cool. During cooking, the fan is always working. Once the oven has been switched off, it can continue working for a while depending on the temperature of the oven, therefore reducing the external temperature of the oven. It is possible to feel the air that leaves between the frontal panel and the oven door.

1.3. SAFETY FOR CHILDREN

- Always keep children at a safe distance and make sure that they do not manipulate the appliance without supervision.
- Never allow small children to play with the oven or turn the control knobs. If the programmer on your oven includes a child-safety mechanism, be sure to use it.

1.4. CARE AND CLEANING

- For reasons of safety and hygiene, always keep the oven clean. The formation of dried grease or other food remains may lead to a bad smell.
- For a longer working life of your oven, it is recommended that general cleaning be carried out frequently.
- The oven must be turned off and sufficiently cooled down before any cleaning or maintenance work is done on the oven, so that it can be touched without danger.
- The oven door must always close tight shut. Keep the door seal clean at all times.
- Never clean the oven with high-pressure cleaners or steam-cleaning machines.
- Do not use corrosive or abrasive cleaners. If a product of this type comes into contact with the oven front, wash it off immediately with water.
- Avoid the use of sponges or scouring pads on the inside of the oven, as they might damage the enamel. Follow the instructions provided in part "4. Cleaning and Maintenance".



2. INSTALLATION AND ASSEMBLY

2.1. UNPACKING

1. Cut the plastic film covering the entire package.
2. Carefully remove all the oven's protective elements: top cover, edge protection and polystyrene base.

With respect to the conservation of the environment, we recommend you follow the advice given in part "6. Environmental Note".

2.2. CONNECTION TO THE MAINS ELECTRICITY

a Free-Standing Ovens

1. The measurements of the furniture unit in which the oven is to be mounted must coincide with those indicated in the diagrams, depending on whether the unit is wall-mounted or floor-based.

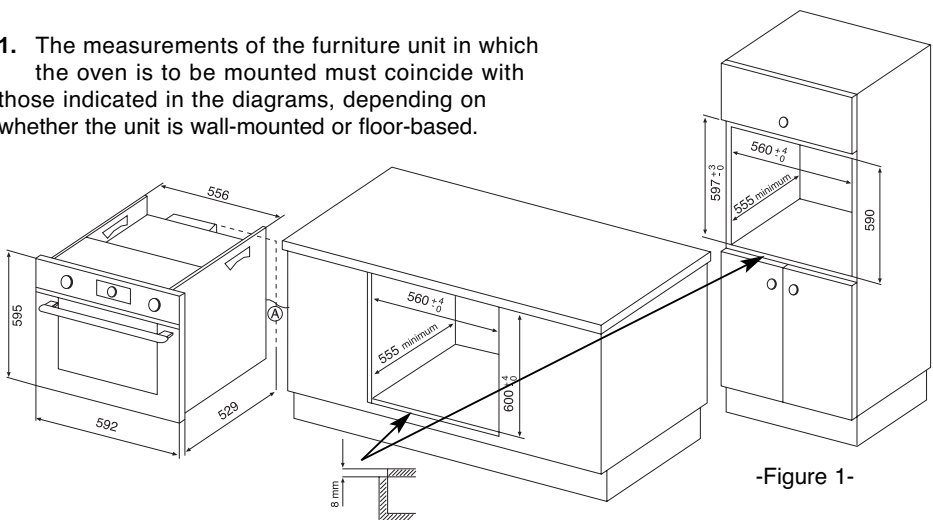

-Figure 1-

2. At the back of the oven you will find cable "A" which is used to make the electrical connection.
3. The appliance must be installed by an authorised installer, complying with the manufacturer's instructions and diagrams.

Before making electrical connections:

- Consult the appliance name-plate, verifying that the network's characteristics are adjusted to the appliance's characteristics.
- Locate and identify the Earth conductor (green/yellow), the Neutral (blue) and the Live (brown) on the end of the appliance power supply cable. Locate and identify these conductors (Earth, Neutral and Live) at the network connection point, thereby checking that the network is suitable.
- Make sure that the network is disconnected to avoid problems leading to injuries or electrocution.

Connect the conductors from the appliance power supply cable to the network conductors, strictly following the colour correspondence, using an appropriate tool (see diagram).

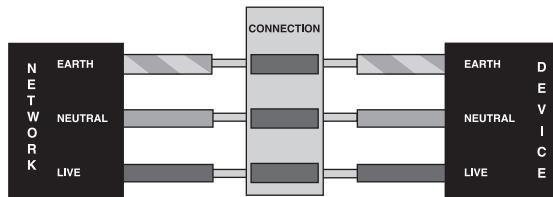

The network circuit which powers the appliance must be equipped with a one-way trip switch with at least 3mm between contacts.

Using this appliance after incorrect installation could damage the appliance, the surroundings and/or people. The manufacturer is not responsible for poor functioning and possible damage derived from incorrect installation.

4. A switch must be placed in the most accessible site possible in order to disconnect the oven, with a minimum of 3 mm between the contacts.
5. Fasten the oven to the unit with the 2 screws you will find in the bag of accessories.

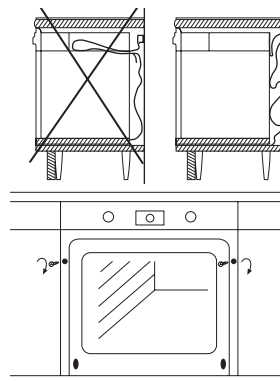

-Figure 2-

6. If the cooking function selector is not at position "0", turn it to "0" and set the time on the oven.

b Multi-purpose Models

b.1 GAS, MIXED, INDUCTION AND 4 ELECTRIC HOBS

1. The measurements of the furniture unit in which the oven is to be mounted must coincide with those indicated in the figure.
2. Screw in the 4 cardans on the hob using the corresponding screws.

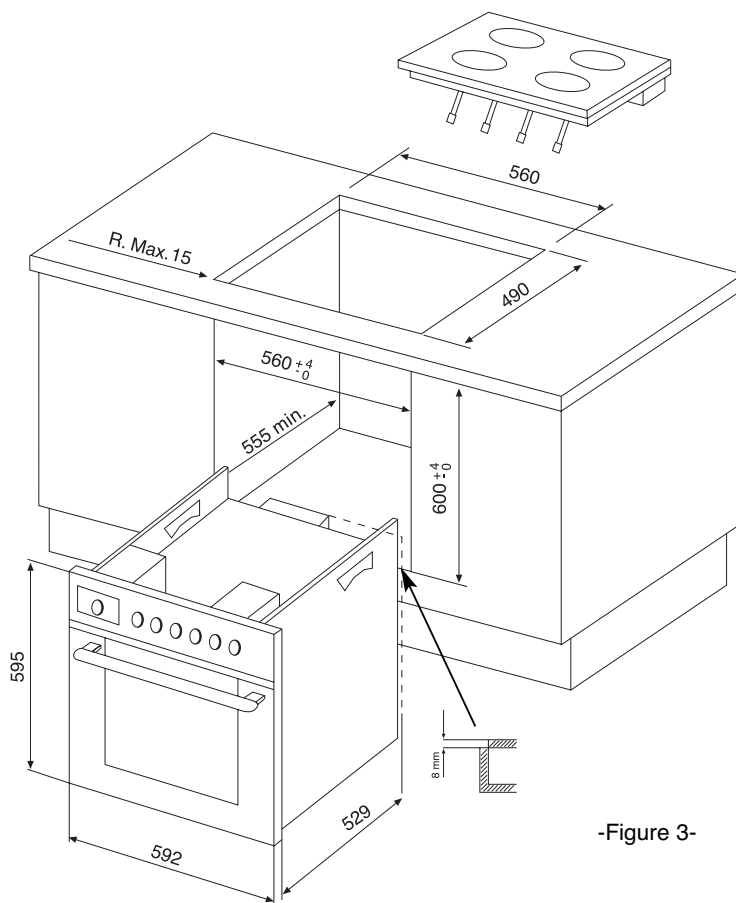

- Next you must place the cooking hob on the worktop, leaving it disconnected until the oven is installed as the oven is connected through the hob. Respect the hob installation requirements (refer to the hob instruction manual).

- Install the bolt-holder support part by inserting it through the two slides ("A") on the oven (see fig. 4).

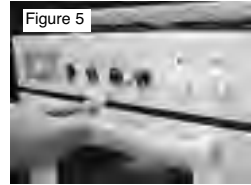
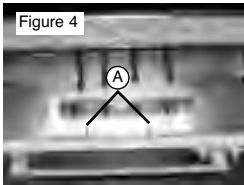

Then fix it in place at the front using two screws (see fig. 5 and 6). All these items come in the hob or oven accessory bag fig. 7.

- Lift the cardans and the cable off the hob, insert the oven into the furniture unit leaving enough space to house the cardans on the bolts, screw them in tight and put the cable into its connection socket.

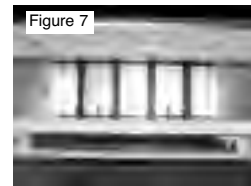
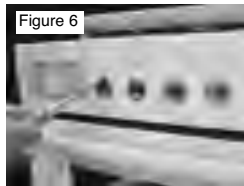

- Push the oven towards the inside and fasten it to the unit with the 2 screws (Figure 2) that you will find in the bag of accessories that came with the oven.
- Push the control knob supplements into place depending on the corresponding type of heat. All the supplements are in the bag of accessories that came with the oven or the cooking hob. Next put the control knobs in place. You will find these in the bag of accessories that came with the oven.

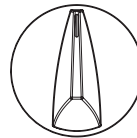
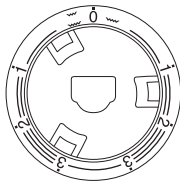

- If the cooking function selector is not at position "0", turn it to "0" and set the time on the oven.

b.2 VITROCERAMIC HOBS

- The measurements of the furniture unit in which the oven is to be mounted must coincide with those indicated in Figure 3.

2. Place the cooking hob on top of the worktop.



3. Release the switch box that goes under the cooking hob.



4. Next you must install the hob over the gap in the worktop, bearing in mind that the switch box is hanging from the hob. Respect the hob installation requirements (refer to the hob instruction manual).

5. Insert the oven into the gap in the furniture unit leaving the switch box on top of the oven.



6. Insert the cable into the oven connector.



7. Insert the switch box over the centring bolts of the component carrier as far as it will go and fasten the 2 screws on the top.

8. Push the oven towards the inside and fasten it to the unit with the 2 screws (Figure 2) that you will find in the bag of accessories that came with the oven.
9. Push the control knob supplements into place depending on the corresponding type of heat. All the supplements are in the bag of accessories that came with the oven or the cooking hob. Next put the control knobs in place. You will find these in the bag of accessories that came with the oven.

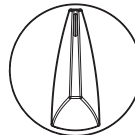
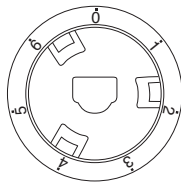

10. If the cooking function selector is not at position "0", turn it to "0" and set the time on the oven.



3. USE OF THE OVEN AND PRACTICAL TIPS

3.1. BEFORE USING THE OVEN FOR THE FIRST TIME

Adjusting the Clock

If the programmer on your new oven includes a clock, we recommend that you set the correct time after connecting the oven to the mains electricity or after a cut in the power supply.

First Cleaning

Before using your new oven for the first time, heat it up with nothing in it for about 30 minutes, with the door closed. Adjust the cooking functions selector in position  and set a temperature of 250°C. Make sure you have removed any possible labels or protective plastic.

At the beginning, the oven may give off a strange smell. Furthermore, you may notice a little smoke. All of this is normal. This is the way to remove any possible remains of grease from the inside of the oven left over from the manufacturing process. Once the oven has cooled down, clean it following the instructions given in part “4. Cleaning and Maintenance”.

Before using any of the accessories included with your new oven for the first time, clean them with water, a little soap and a cloth.

3.2. GENERAL DESCRIPTION

FREE-STANDING OVENS

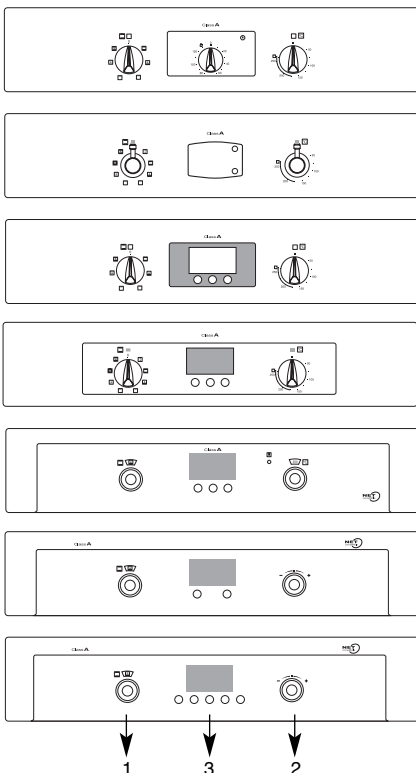

MULTI-PURPOSE OVENS

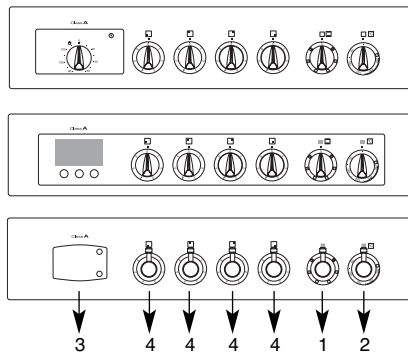

1. Function Selector
2. Temperature Selector
3. Programmer
4. Hob Operation Controls

a Cooking Function Selector

Your oven offers different cooking functions. With the cooking function selector, you will be able to select the most suitable cooking function at any time for the preparation of the food in question.





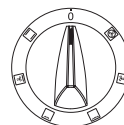





If the oven has fixed controls, the cooking function selector can be turned to the left or right without any problem.

If your oven has controls that can be hidden away, the cooking function selector can be turned to the left or right without any problem. These controls can be hidden and revealed again in any position just by pushing them.



*Different number of functions depending on the model.

Now read below only the description of those functions coinciding with the symbols appearing on your function selector:

-  **Traditional Heat:** With this function, the heat comes from both above and below, heating the food in the traditional way.
-  **Bottom Heat:** The heat comes from the lower part of the oven. This is the most appropriate function for finishing off the cooking of your food.
-  **Gentle Grill or Gentle Grill with rotating spit:** Only the central part of the grill resistance is connected, allowing you to save power when toasting smaller portions of food. Place the items in the central part of the grill. (Rotating spit available in certain models only).
-  **Strong Grill:** The action of the grill covers the entire surface of the tray, allowing you to toast large trays or several items of food at the same time. This setting is suitable for cooking the same food as with the gentle grill but covering the whole of the tray surface. Very appropriate for all types of toasting.
-  **Bottom Heat with Fan:** The fan uniformly distributes the temperature generated at the bottom of the oven.
-  **Strong Grill with Fan:** Special option that allows toasting of food and an even distribution of the heat with a fan. Ideal for grilling large roasts. In this way, roast meats take on a golden colour all over
-  **Traditional Heat with Fan:** The heat comes from both the top and the bottom of the oven and the fan distributes the temperature evenly. You can cook different dishes on different levels at the same time without mixing smells or flavours.
-  **Thawing:** This heats the resistances to a very low temperature, so as to achieve an even and fast thawing of frozen food. The thawing function can be used with any type of frozen food.
-  **Turbo Plus:** The oven is heated with the circular resistance located at the back. The fan drives the hot air around the oven to distribute the heat more evenly. Ideal for working with different trays at various heights.
-  **Celeris:** Suitable for those dishes that need the oven to be pre-heated. With this function the oven is heated to the chosen temperature in as little time as possible. Once the oven has reached the temperature set, the thermostat pilot light goes out, indicating that the oven is ready to be used for any other cooking function.
-  **Pizza:** The strong heat coming from the bottom area and the even distribution of the temperature with the fan gives pizzas a particularly crisp base.

The **general power pilot light** will remain on whenever any cooking function is selected.

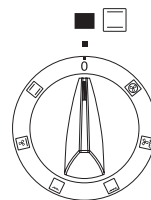

b Temperature Selector

Using the temperature selector, you can adjust the cooking temperature at any time to the most suitable for preparing the food in question. The control turns to the right from 50°C up to 250°C.

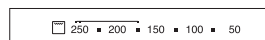
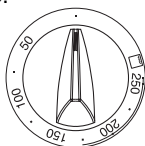

If your oven has no temperature selection control, follow the instructions given in the section entitled “Electronic temperature control” in the timer manual.

The **thermostat pilot light** will go out when the selected temperature is reached and then it will come on and off from time to time while cooking to keep the right temperature.

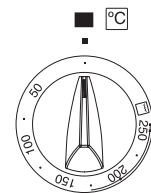

3.3. OPERATION OF THE OVEN

Follow these steps to turn on your oven:

1. Place the food in the oven, on the recommended tray and level (see tables).
2. Select a cooking function using the cooking function selector (see tables). For example:
3. Set a temperature by turning the temperature selector or following the instructions given in the timer operating manual (see tables). For example: 150°C.

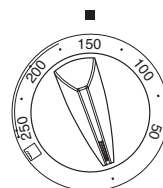
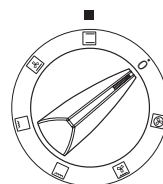
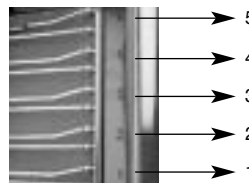

4. To set the programmer, follow the instructions provided in the specific user manual (separate manual).
5. Once the cooking is finished, do not forget to turn the function selector back to the "0" position and the temperature selector to the lowest position "■"

3.4. ACCESSORIES

The oven has 5 different levels on which to place the accessories. These levels are engraved at the entrance to the cavity. If you wish, you can acquire additional accessories by requesting them from our Official Technical Service.

Your oven comes from the factory with some of the accessories described below:

Depending on the model:

Baking Tray

Aluminium tray ideal for baking.



Standard Tray

For all kinds of food.



Deep Tray

The new deep tray is suitable for cooking dishes with a large amount of sauce or gravy, ideal for juicy cakes, frozen food and large roasts.



Grille with Non-Tip Safety Catch

The new grille with its non-tip safety catch can be slid out of its housing about three quarters of the way without it tipping over. In this way, you will be able to remove food easily from inside the oven. In addition, it gives you the possibility of using it at any of the 5 levels available in the oven.

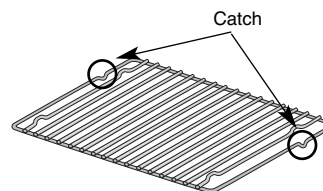

This grille can be used to hold any kind of container with food to be roasted or toasted. It is also used for making roasts directly on the slats of the grille, in which case we recommend you place a tray underneath the grille to collect any juices given off by the meat and to keep your oven clean.

The grille has to be slid into place on the side slots with the catches facing down, as indicated in the figure.

Pull System

The new "Pull System" design ensures a safe and convenient handling of the food, which can be placed at any of the 5 levels of the oven. The trays can be pulled out of their housing about three quarters of the way without tipping over or wobbling, thus reducing the risk of burns. In this way, you will be able to remove food easily from inside the oven.

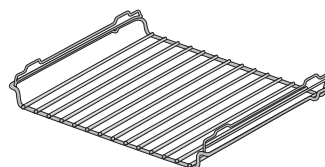

To insert the trays into the oven:

1. Insert the "Pull System" into the side slots until it reaches the limits; you will have to raise it slightly to pass it over the catches.



2. Next insert any of the trays onto the upper part of the “Pull System”, fitting it between the four upper catches.

If you wish you can also insert the grille with its non-tip safety feature on the combination of the “Pull System” and tray but with its catches facing upwards.



3. Insert the whole set inside the oven completely.



To remove the trays from inside the oven:

Once cooking has been completed, slide the tray and grille set out until it reaches the limit, once there you can do one of two things, as required:

- a. Extract only the tray from inside the oven.
- b. Extract the whole set from inside the oven. To do so, you will have to lift the “Pull System” slightly to get past the catches that prevent it from tipping over.

Remember that the “Pull System” set of tray and/or grille with its non-tip safety feature can be placed on any of the 5 levels.

Removable tray, Total Accessibility

With the new “Removable tray, Total Accessibility”, food handling is more convenient and easier thanks to the carefully studied design allowing the trays to slide in and out smoothly.

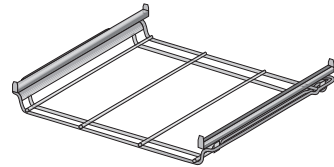

The trays can be taken completely out of their housing for total accessibility. In addition, they remain totally stable so that you can work and handle them in total safety, reducing the risk of burns. This will make it easier for you to remove food from inside the oven.

This new total extraction system can be placed on any of the bottom 4 levels of the oven, multiplying the cooking potential even more.

To insert the trays inside the oven:

1. Insert the “Removable tray, Total Accessibility” onto the side slots as far as it will go; you will have to raise it lightly to get past the catches. Bear in mind that the round pegs go at the back.



2. Next, pull out the telescopic runners as far as they will go.



3. Then fit any of the trays inside the 4 upper catches on the telescopic runners.

If you wish you can also insert the grille with its non-tip safety feature on top of the combination of the “Removable Tray”, but with the catches facing upwards.



4. Insert the whole set inside the oven completely.



To remove the trays from inside the oven:

Once cooking has been completed, slide the tray and grille set out, once there you can do one of two things, as required:

- a. Extract only the tray from inside the oven.
- b. Extract the whole set from inside the oven. To do so, you will have to lift the “Removable tray, Total Accessibility” slightly to get past the catches that prevent it from tipping over.

Remember that the “Removable tray, Total Accessibility” set of tray and/or grille with its non-tip safety feature can be placed on any of the 5 lower levels.

3.5. ROTATING SPIT

If your oven is fitted with a rotating spit, follow the steps described below:

1. Place the spit hook "A" on the spit support "B", as shown in Figure 1 and then place it inside the oven as shown in Figure 2.

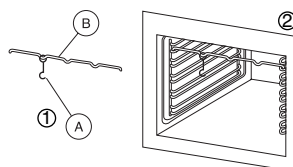

2. Insert the spit in the food you want to roast and hold it in place with the sliding jabs.

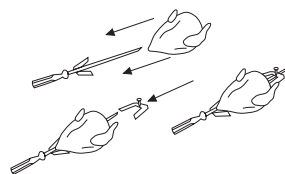

3. Insert the spit into the hole at the back of the oven and place the other end on the spit support. Place a tray on the lowest level to catch any juices dripping off the food and unscrew the handle of the spit to be able to close the door.

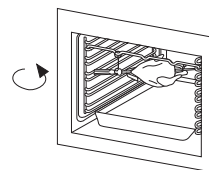

4. Switch the oven on using the Grill with Spit programme  and set the temperature selector at 200°C.

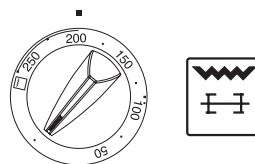

5. When the roast is ready, screw the handle back onto the spit and take it out of the oven. Release the sliding jabs and pull the spit out of the food.

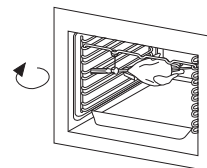











































3.6. PRACTICAL ADVICE AND COOKING TABLE

a Suggestions and Practical Tips for Baking

PROBLEM	POSSIBLE REASON	SOLUTION
Cakes and pastries do not rise enough	<ul style="list-style-type: none"> •Wrong function selected •The oven has not been pre-heated enough 	<ul style="list-style-type: none"> •Check the function selected against the temperature shown in the table •Check the table for any pre-heating recommendations
The roast or the baking is very pale	<ul style="list-style-type: none"> •Temperature too low •Inappropriate mould material 	<ul style="list-style-type: none"> •Check the temperature selected against the temperature shown in the table; increase it slightly if necessary •Use only dark moulds
The roast or the baking is very dark	<ul style="list-style-type: none"> •Temperature too high 	<ul style="list-style-type: none"> •Check the temperature selected against the temperature shown in the table; reduce it slightly if necessary
The roast or the baking is very dry	<ul style="list-style-type: none"> •The cooking time is very long because the temperature selected is too low 	<ul style="list-style-type: none"> •Check the temperature selected against the temperature shown in the table
The roast or the baking is very wet	<ul style="list-style-type: none"> •Too much liquid in the dough 	<ul style="list-style-type: none"> •Check the temperature selected against the temperature shown in the table; increase it slightly if necessary. •Prepare the dough with less liquid.

b Tables

FOOD	PRO-GRAMME	TEMPERATURE	TIME	POSITION FOOD	PRE-HEATING	ACCESSORIES
MEAT AND POULTRY						
Veal 1,5 kg		210°	50-60 min		No	
Pork loin 1,5 kg		220°	50-60 min		No	
Roast chicken 1,25 kg		230°	50-60 min		No	
Roast rabbit 1,2 kg		210°	25-35 min		No	 
Roast lamb 1 kg		220°	40-50 min		No	 
Pork leg 1,5 kg		180°	85-95 min		No	
Pork ribs 1,5 kg		220°	30-40 min		No	 
Turkey legs (2)		170°	40-50 min		No	
Turkey 4 kg		190°	115-125 min		No	
DESSERTS						
Caramel custard		150°	30-40 min		No	
Sponge cake		180°	25-35 min		Yes	
Pears baked in wine		240°	50-60 min		No	
Pastries		220°	8-12 min		No	

FOOD	PRO-GRAMME	TEMPERATURE	TIME	POSITION FOOD	PRE-HEATING	ACCESSORIES
STARTERS AND VEGETABLES						
Stuffed aubergines		220°	12-16 min	2	Yes	
Roast red peppers 1,25 kg		210°	30-40 min	2	No	
Stuffed tomatoes (4)		220°	15-19 min	2	No	
Stuffed courgettes (2)		200°	25-35 min	1	No	
FISH AND SEAFOOD						
Roast hake 1,5 kg		230°	7-9 min	2	Yes	
Baked prawns 1 kg		240°	4 min	4	Yes	
Trout 1 kg		250°	9-11 min	3	Yes	
Tuna fillets		230°	10-14 min	3	No	
Roast fish 1kg		220°	13-17 min	2	No	
Baked salmon (4)		250°	8-10 min	3	Yes	
Baked cod 1,5 kg		220°	7-9 min	2	Yes	
VARIOUS						
Pizza		220°	18-22 min	1	Yes	
Bread		220°	18-22 min	2	No	
Buns		210°	15-19 min	2	Yes	

FOOD	PRO-GRAMME	TEMPERATURE	TIME	POSITION FOOD	PRE-HEATING	ACCESSORIES
MEAT AND POULTRY						
Veal 1,5 kg		190°	50-60 min		No	
Pork loin 1,5 kg		200°	50-60 min		No	
Roast chicken 1,25 kg		210°	50-60 min		No	
Roast rabbit 1,2 kg		230°	25-35 min		No	
Roast lamb 1 kg		200°	40-55 min		No	
Pork leg 1,5 kg		150°	85-95 min		No	
Pork ribs 1,5 kg		200°	30-40 min		No	
Turkey legs pavo (2)		150°	40-50 min		No	
Turkey 4 kg		170°	115-125 min		No	
DESSERTS						
Caramel custard		150°	30-40min		No	
Sponge cake		180°	15-25min		No	
Pears baked in wine		220°	50-60min		No	
Pastries		200°	8-12min		No	
THAWING						
For all kinds of food		75°			No	

FOOD	PRO-GRAMME	TEMPERATURE	TIME	POSITION FOOD	PRE-HEATING	ACCESSORIES
STARTERS AND VEGETABLES						
Stuffed aubergines		200°	12-16 min	2	Yes	
Roast red peppers 1,25 kg		190°	30-40 min	2	No	
Stuffed tomatoes (4)		200°	15-19 min	2	No	
Stuffed courgettes (2)		180°	25-35 min	1	No	
FISH AND SEAFOOD						
Roast hake 1,5 kg		210°	7-9 min	2	Yes	
Baked prawns 1 kg		220°	4 min	4	Yes	
Trout 1 kg		240°	9-11 min	3	Yes	
Tuna fillets		250°	10-14 min	3	No	
Roast fish 1kg		200°	13-17 min	2	Yes	
Baked salmon (4)		240°	8-10 min	3	Yes	
Baked cod 1,5 kg		210°	7-9 min	2	Yes	
VARIOUS						
Pizza		200°	18-22 min	2	No	
Bread		200°	18-22 min	2	No	
Buns		220°	13-17 min	2	Yes	

4. CLEANING AND MAINTENANCE OF THE OVEN

4.1. HOW TO CLEAN...

4.1.1. The Outside of the Oven

a. Ovens with an enamelled front:

Clean the outside of the oven preferably with warm soapy water. Abundant rinsing is recommended. Dry it immediately afterwards with a soft cloth.

b. Ovens with stainless-steel front:

Clean the outside of the oven preferably with warm water and a little washing-up liquid. Abundant rinsing is recommended. Dry it immediately afterwards with a soft cloth.

If any stains are difficult to remove we recommend you use products specifically designed for stainless steel. Test the product on a small area before you apply it to the entire surface. Follow the manufacturer's indications closely.

Si las manchas son difíciles de eliminar le recomendamos que use productos específicos para acero inoxidable. Pruebe el producto en áreas pequeñas antes de aplicarlo a toda la superficie. Siga escrupulosamente las indicaciones del fabricante.

c. Ovens with aluminium front:

Clean the outside of the oven with warm soapy water and a soft sponge. Abundant rinsing is recommended. Dry it immediately afterwards with a soft cloth.

Aggressive detergents, scouring pads and rough cloths should not be used.

d. Ovens with glass front:

Use a mild window cleaner. Clean the surface with a soft window-cloth or a lint-free cloth with microscopic fibres without applying too much pressure.

4.1.2. The Inside of the Oven

In order to ensure the continued aesthetic attractiveness of your oven in the long term, you should clean the inside of it regularly, preferably every time you use it; this way you will avoid the generation of smoke and unpleasant odours in subsequent uses.

a. Ovens with “Slide” enamel:

Our new “Slide” enamel ensures minimal adherence of any food to the internal surfaces of the oven, so this enamel is easy to clean. Clean the inside of the oven while it is still warm using hot water with a little soap or a solution of water and vinegar; after cleaning, dry the inner walls thoroughly with a soft cloth.

For in-depth cleaning or if the dirt is particularly difficult to remove, we recommend the use of specialised oven-cleaners, following the manufacturer’s instructions. Only ever use specialised oven-cleaners on a cold oven.

b. Ovens with self-cleaning panels:

In ovens with self-cleaning panels the rear plate and the side panels are coated with a self-cleaning enamel that eliminates fat and grease while the oven is operating. These side panels are reversible, which doubles the lifetime of their catalytic coating.



Sometimes, the largest splashes do not disappear until the oven has been turned on and off several times. When the self-cleaning elements of your oven no longer clean themselves well enough, it will be necessary to regenerate them. To do so, please follow the steps outlined below:

1. Remove the accessories and containers from the inside of the oven.
2. Thoroughly clean the oven surfaces that are not self-cleaning.
3. Place the function selector to position .
4. Adjust the oven temperature to 250°C.
5. We recommend you leave the oven operating for between 30 and 60 minutes, depending on the degree of dirt and grime on the self-cleaning parts.
6. Clean off any remnants of salt from the self-cleaning elements using a slightly damp sponge (water only).

The self-cleaning elements of the oven will be completely functional again.

WARNING: Never clean the rear plate or the side panels with specialist oven-cleaners.

If you wish to clean the side walls on the inside of the oven, you will first have to take out the grilles and the self-cleaning panels located behind them (follow the instructions given in sub-part "4.1.4. How to clean the side grilles").

Clean the side walls on the inside of the oven while it is still warm using hot water with a little soap; dry the walls carefully with a soft cloth.

For in-depth cleaning or if the dirt is particularly difficult to remove, we recommend the use of specialised oven-cleaners, following the manufacturer's instructions. Only ever use specialised oven-cleaners on a cold oven.

WARNING: Never apply this product to the oven's self-cleaning surfaces.

To make the cleaning of the inside of the oven easier:

- Connect the interior lamp. To do so: turn the temperature selector to the "0" position and the function selector to any function, the light will then be on.
- If you want to clean the glass cover protecting the oven lamp: unscrew the cover and clean it, preferably with washing-up liquid.



Once it is clean, replace the lamp cover following the procedure described.

- It is possible to remove the oven door easily. Follow the steps described below very carefully:

How to remove the door:

1. Open the door fully.



2. Completely raise the bolts in the hinges.



3. Close the oven door gently until you hear the catch engage; once you reach the position of the catch, take hold of the door with both hands and continue to push it closed while pulling upwards at the same time to lift the hinges from their slots. The door will then be released.



How to install the door after cleaning:

1. Align the hinges with their slots until they hook into place, as indicated in the figures.



2. Open the door fully, and push the bolts down completely to their original position. The door will then be correctly installed.



- In some ovens it is possible to fold down the grill in the roof of the oven.
WARNING: the oven must be cold.

How to fold the grill down:

1. Lift up the grill rod.
2. Press it in towards the back of the oven.



How to re-insert the grill after cleaning:

1. Press the grill's rod towards the back of the oven and hook the grill back into place in its support.

4.1.3. Accessories

Soak the accessories immediately after use in a normal household detergent. In this way, any adhered food scraps can be easily removed with a sponge or a soft brush.

4.1.4. Side Grilles

The grilles can be removed for cleaning (There are two type of grilles depending on the type of fastening). To do so, follow the steps described below:

How to remove the grilles:

Type 1 fastening: With support

1. Press the grille's upper rod downwards to unhook it from the support on the side panel.



2. Turn the grille as shown in the figure and pull it outwards to extract it.



3. If your oven is self-cleaning, unhook the panel located behind the grille.

Type 2 fastening: No support

1. Lift the grille by the part closest to the oven mouth and turn it until it is released from the hole.



2. Move the grille back to the oven mouth.



3. Lift the grille by the part closest to the oven floor and turn it until it can be extracted completely.



Clean the grilles in the dishwasher. To eliminate any stubborn dirt you can use rougher cleaning sponges or brushes.

How to re-insert the grilles after cleaning:

Replace the grilles on the side walls by following the steps indicated above but in reverse order.

4.2. HOW TO REPLACE THE BULB IN THE INTERIOR LIGHT

You can replace the bulb for the oven's interior light by yourself if it stops working. You can obtain these heat-resistant 25W replacement bulbs capable of with standing 300°C from the Official Technical Service or from a specialised electrical store. To replace the bulb do the following:

1. Disconnect the oven from the power mains. If necessary, let the oven cool down.
2. Unscrew the cover over the lamp by turning it to the left.
3. Replace the bulb with one of the same type.
4. Replace the glass cover on the lamp following the procedure described.
5. Re-connect the oven to the power mains.









▶ 5. TROUBLESHOOTING

There may be small anomalies that do not necessarily mean the existence of a product failure and so do not require a Technical Service call-out.

These small anomalies are often easy to correct. In order to avoid an unnecessary call-out of a Service Engineer, check to see if the failure you have encountered is included in the table below:

If your oven is still not working correctly after checking the points indicated in the table, call the Technical Service department indicating the type of failure, the appliance model, the product number and the serial number indicated on the features identification plate. This plate is on the lower front face of the oven cavity.

Any repairs necessary must be carried out by Service Engineers from an Official Technical Service. Any repairs made incorrectly might give rise to serious risk for users. To resolve a doubt, make a query, or lodge a complaint in connection with the guarantee or report a failure of your oven, contact **FAGOR** or, if you prefer, visit our web site: www.fagor.com.

YOU NOTICE THAT...	POSSIBLE REASONS	WHAT TO DO
The oven is NOT working. The luminous symbols are not lit.	<ul style="list-style-type: none"> •No power supply. •The oven is not connected. 	<ul style="list-style-type: none"> •Check the status of the electrical installation. •Connect the oven.
The oven is NOT working.	<ul style="list-style-type: none"> •The timer control is in position "0" or  	<ul style="list-style-type: none"> •Turn the selector manually  or set the desired cooking time.
The oven is making a series of beeps.	<ul style="list-style-type: none"> •Several reasons. 	<ul style="list-style-type: none"> •Read the timer's user manual carefully.
The oven is NOT working.  symbol is flashing.	<ul style="list-style-type: none"> •Several hours have passed with the oven operating, without any timer button being pressed. •Interruption of the power supply, with the function selector not in position "0". •Oven installed with the function selector not in position "0". 	<ul style="list-style-type: none"> •Turn the function selector to the "0" position. •Turn the function selector to the "0" position and set the clock to the right time.
The oven is NOT working.  symbol is flashing.	Oven just installed, or interruption in the power supply, with the function selector not in position "0".	Set the clock to the right time and the oven will start.
The oven is NOT working.  symbol is flashing.	The time pre-set for cooking has elapsed.	Turn the function selector and The temperature selector to the "0" position.
The oven is NOT working.  symbol is lit.	Oven blocked with the function selector in position "0".	Release the timer as indicated in the "Child Safety Lock" part of the timer's user manual.
The oven IS working, but the  symbol is flashing.	The time set for the oven alarm has elapsed.	Press any button.
The oven light is NOT working.	<ul style="list-style-type: none"> •The lamp is not operational. •The oven is not connected or your electrical system has a fault and the fuse has tripped. 	<ul style="list-style-type: none"> •Change the bulb. •Connect the oven or check if the fuse has tripped.
Smoke comes out when in use.	<ul style="list-style-type: none"> •Oven temperature is too high. •Greasy oven. 	<ul style="list-style-type: none"> •Reduce the oven temperature. •Clean the oven.
The oven makes a noise after cooking is completed.	The oven fan is operating (even with the oven off), to cool down the temperature in the surroundings.	This is absolutely normal.
The interior glass of the oven door is misted up and dripping.	An accessory (grille, tray) is in contact with the glass.	Push the accessory further in to prevent it coming into contact with the glass.



6. ENVIRONMENTAL NOTE

6.1. PROTECTING THE ENVIRONMENT

Our company strives permanently to develop technologies and solutions aimed at reducing energy consumption and preserving natural resources, thus effectively contributing to a reduction in the aggressions suffered by the environment.

Disposing of the packaging from your new oven

Your new oven is covered by protective packaging during its transportation to your home. All of the packaging materials used are environmentally-friendly and can be recycled or re-used.

Make an active contribution to protecting the environment by using appropriate methods for recycling and disposing of packaging materials. Your local council will be pleased to inform you of the most efficient and up to date possibilities available for the elimination of these materials.

6.2. ENERGY-SAVING TIPS

- Pre-heat the oven only where this is indicated in the recipe or in the cooking table for the dish you want to make.
- It is better to use dark baking moulds, preferably enamelled in black, as these materials absorb heat particularly well.
- If you wish to bake a batch of several cakes, you should do so one after the other. As the oven is already hot, the baking times of second and subsequent cakes are shorter. You can also prepare two cakes simultaneously by placing rectangular moulds side by side.
- If using the oven continuously for a long time, you can switch it off 5 or 10 minutes before the time indicated and take advantage of the residual heat to finish preparing the food.
- If your oven includes the “Gentle Grill”  function, use it to prepare small amounts of grilled food, placing the food in the central part of the tray or grille.

ENVIRONMENTAL TIPS



In order to protect the environment, deliver your used appliance to an official collection centre or recyclable material recovery centre.

Before you dispose of your used appliance, make it unusable by cutting the power cable.

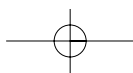
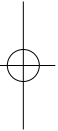
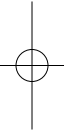
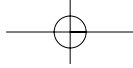

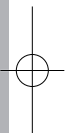
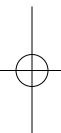

06-07



C60T206A9

Printed on recycled paper

